

Article number: 201000030
 Description: E+G Power clamp
 GN 864-32-BL

Measures

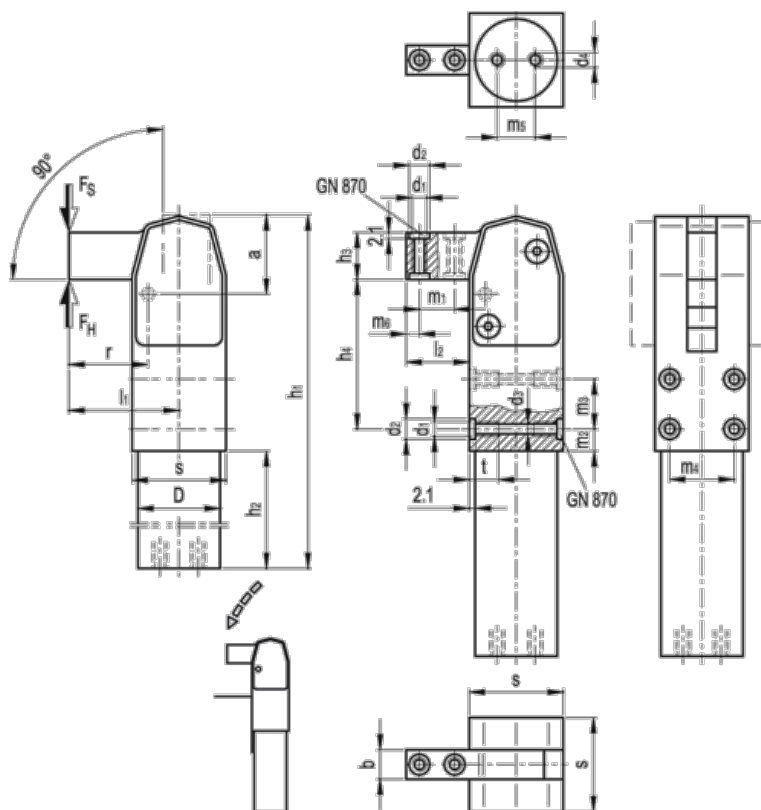

a	= 37	h1 -0.5	= 206	m2	= 42
b -0.2	= 12	h2	= 91	m3 +/-0.01	= 15
Clamping force at 6 bar (approx.)	= 4110	h3	= 21	Weight (g)	= 1500
d1	= M6	h4	= 75.5	m5	=
d2 H8	= 9	Holding force FH (N)	= 5620	m6	=
d3	= 5.0	l1	= 206	Max clamping moment (Nm)	=
d4	= G 1/8	l2	= 52.0	Piston diameter	=
d h8	= 40	m1 +/-0.01	= 18	r	=